

# GÔNDOLAS E CHECK-OUTS



**EQUIPAMENTOS COMERCIAIS LTDA**  
A TECNOLOGIA DO FUTURO É O NOSSO PRESENTE

# QUEM SOMOS

## + 30 ANOS

Desde 1991, oferecemos soluções práticas na exposição e conservação de produtos dos mais variados segmentos, garantindo uma acomodação e visão apropriada para cada categoria e relevância no ponto de venda. De padarias, supermercados, açougues, fruteiras a ferragens, o grande diferencial é a possibilidade de personalização, adequando-se as diversas finalidades.

### POR QUE ESCOLHER A PERACCHI:

- Representantes em todo o Brasil;
- Rigoroso controle de qualidade;
- Agilidade no atendimento;
- Transparência nas negociações;
- Tradição e experiência no mercado;
- Profissionais treinados e qualificados;
- Certificada pelo INMETRO;
- Fornecedores de qualidade;
- Alta resistência e durabilidade;
- Ótimo custo benefício;
- Constante pesquisa e inovação.



ACOMPANHE NOSSAS  
REDES SOCIAIS

 [peracchi.ind.br](http://peracchi.ind.br)

 [peracchi.ltda](https://www.facebook.com/peracchi.ltda)

 [peracchi.equipamentos](https://www.instagram.com/peracchi.equipamentos)

 [atendimento02@peracchi.ind.br](mailto:atendimento02@peracchi.ind.br)

 /  (49) 3452-1426

 R. Itália, 1124, B. Nações  
Seara - SC





# SUMÁRIO

<b>PONTAS DE GÔNDOLA</b>	<b>03</b>
<b>GÔNDOLAS PARA CEREAIS</b>	<b>06</b>
<b>GÔNDOLAS CENTRAIS</b>	<b>07</b>
<b>GÔNDOLAS LATERAIS</b>	<b>09</b>
<b>GÔNDOLAS BAT RACK</b>	<b>11</b>
<b>GÔNDOLAS PARA FARMÁCIA</b>	<b>17</b>
<b>ACESSÓRIOS PARA GÔNDOLAS</b>	<b>18</b>
<b>CORES E DETALHES</b>	<b>21</b>
<b>CHECK OUTS</b>	<b>22</b>

**Devido a constante pesquisa de desenvolvimento e melhorias de nossos produtos, as informações e imagens deste catálogo são ilustrativas e poderão sofrer alterações sem aviso prévio.**

## DIVERSIFICADAS POSSIBILIDADES DE PAGAMENTO



Financiamento pelos programas:



# PGP 3 FACES

EXPOSIÇÃO EM 3 FACES = MAIOR DESTAQUE PARA O SEU PRODUTO



ILUMINAÇÃO  
BARRAS DE LEDs

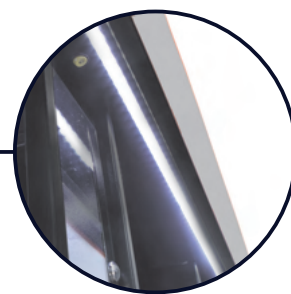

VIDRO TEMPERADO  
COM SERIGRAFIA

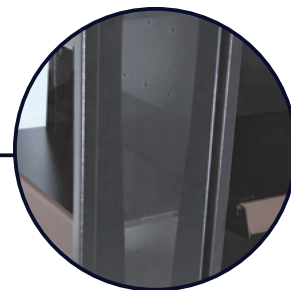

PAINEL DE FUNDO  
LATERAL PERFURADO  
PARA GANCHOS

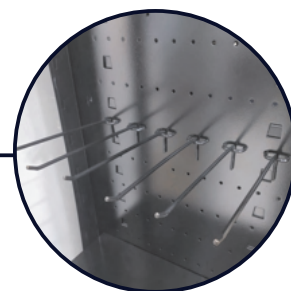

PARA-CHOQUE  
AUTO IMPACTO

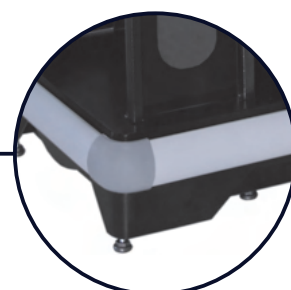

## DIMENSÕES

Altura total 2,10m

**01** Podium de 1,21m C. x 0,52 L. x 0,20m A.

**05** Bandejas Centrais de 0,63m C. x 0,40m L.

**10** Bandejas Laterais de 0,435m C. x 0,21m L.

CAPACIDADE

**90 KG**

POR BANDEJA CENTRAL

CAPACIDADE

**30 KG**

POR BANDEJA LATERAL

PODIUM **300 KG**



# PGPs

ACABAMENTO PERFEITO  
PARA GÔNDOLAS CENTRAIS

PODIUM  
**300<sup>KG</sup>**

CAPACIDADE  
**90<sup>KG</sup>**  
POR BANDEJA

## DIMENSÕES

2,10m = 5 bandejas + 1 podium;

1,80m = 4 bandejas + 1 podium;

1,30m = 3 bandejas + 1 podium.

### Podium:

0,94m C. x 0,50m L. x 0,20m A.

### Bandejas:

0,905m C. x 0,34m L.



# SUPERMERCADOS





# CEREAIS

# MCEP

## MÓDULO PARA CEREAIS E LINHA PESADA

CAPACIDADE  
**120<sup>KG</sup>**  
POR BANDEJA

CAPACIDADE BASE  
**800<sup>KG</sup>**

BASE COM  
REFORÇO EXTRA

### DIMENSÕES

1,80m = 1 base + 2 bandejas;  
2,10m = 1 base + 3 bandejas.

### Base:

0,99m C. x 0,70m L.

### Bandejas:

0,99m C. x 0,34m L.

PASSO  
**25<sup>MM</sup>**



**MÁXIMO APROVEITAMENTO  
DE ÁREAS CENTRAIS**

BRACINHO COM  
MAIOR AMPLITUDE



QUATRO PONTOS DE  
APOIO NO CAVALETE



POSSIBILIDADE DE  
INCLINAÇÃO DA BANDEJA

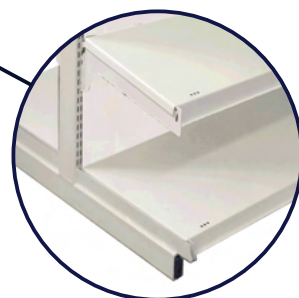

PASSO  
**25** MM

MAIOR  
VERSATILIDADE  
NA REGULAGEM  
DAS BANDEJAS

CAPACIDADE  
**120** KG  
POR BANDEJA

## DIMENSÕES

2,10m = 2 bases + 10 bandejas;

1,80m = 2 bases + 8 bandejas;

1,30m = 2 bases + 6 bandejas.

## Base:

0,99m C. x 0,40m L.

## Bandejas:

0,99m C. x 0,34m L.





ALTURAS 2,10m E 1,80m IDEAL PARA CORREDORES LATERAIS

BRAÇINHO COM  
MAIOR AMPLITUDE



QUATRO PONTOS DE  
APOIO NO CAVALETE



POSSIBILIDADE DE  
INCLINAÇÃO DA BANDEJA

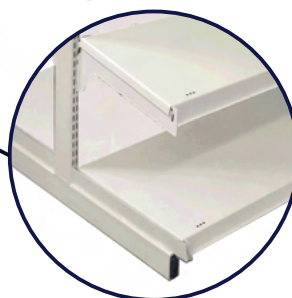

ALTURA 1,30M IDEAL  
CORREDORES CENTRAIS

PASSO  
**25**MM

### DIMENSÕES

2,10m = 1 base + 5 bandejas;  
1,80m = 1 base + 4 bandejas;  
1,30m = 1 base + 3 bandejas.

CAPACIDADE  
**120**KG  
POR BANDEJA

**Base:**  
0,99m C. x 0,40m L.

**Bandejas:**  
0,99m C. x 0,34m L.

## CANTO INTERNO

### MÓDULO PARA CANTO

Acabamento perfeito para os cantos;  
Maximização do espaço, para melhor aproveitamento;  
Melhor organização e visualização na exposição dos produtos;  
Opção de canto interno e externo.

### DIMENSÕES COMPATÍVEIS COM:

MLP: Gôndolas Laterais;

MCEP: Gôndolas para Cereais;

MBRP: Gôndolas Bat Rack.

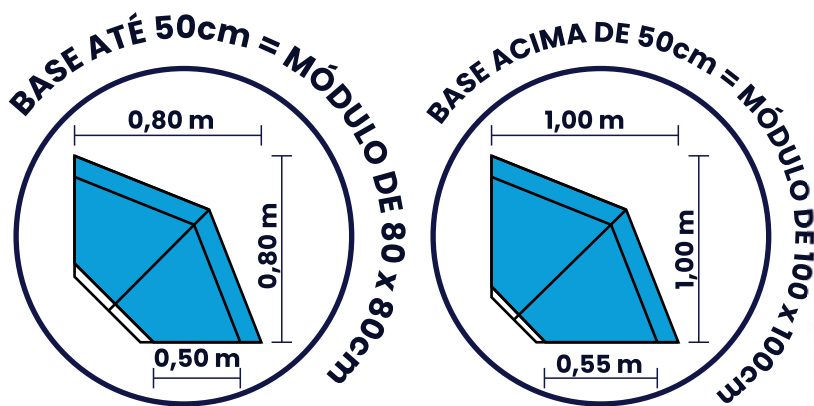

## CANTO EXTERNO



# BAT RACK

# MBRP

**IDEAL PARA ITENS PESADOS, COMO BEBIDAS**

CAVALETE FRONTAL  
MAIOR CAPACIDADE



TUBO 40X60MM

CAVALETE LATERAL



TUBO 40X80MM

## DIMENSÕES

2,10m = 1 base +  
4 bandejas;

### Base:

0,99m C. x 0,65m L.

### Bandejas:

0,99m C. x 0,65m L.

CAPACIDADE  
**150<sup>KG</sup>**  
POR BANDEJA

PASSO  
**60<sup>MM</sup>**





# PET SHOP





## PODIUM

# PBP

### DIMENSÕES

Altura 15cm

**PBP 01:** 1,50m C. x 1,20m L.

**PBP 02:** 1,70m C. x 1,00m L.

**PBP 03:** 1,00m C. x 1,00m L.

**PBP 04:** 0,80m C. x 1,20m L.

**PBP 05:** 0,80m C. x 1,00m L.

### DESTAQUE ESPECIAL PARA PROMOÇÕES



BRANCO

CORES

PRETO

PARA-  
CHOQUE

CINZA

# FERRAGENS





## PORTA ETIQUETAS

Abertura Inferior;  
Visor cristal / transparente;  
Diversas opções de cores.

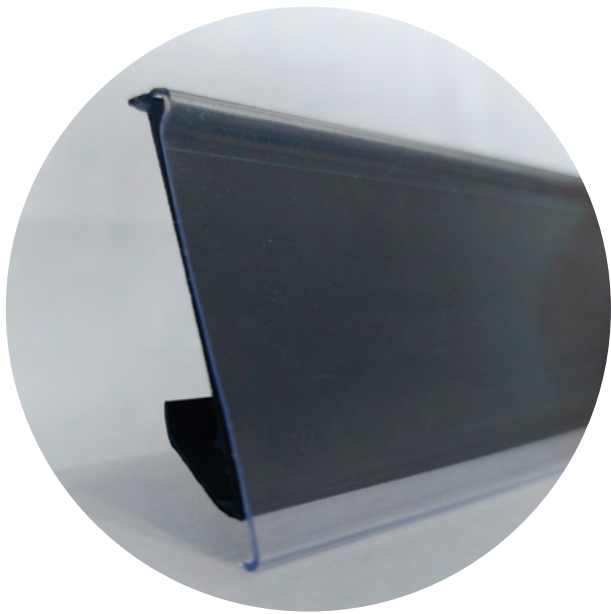

PE 01 - Para bandejas de Gôndola de 977mm C.;  
PE 02 - Para bandejas de Ponta de Gôndola de 887mm C.;  
PE 03 - Avulso ao metro.

## DUPLA FACE

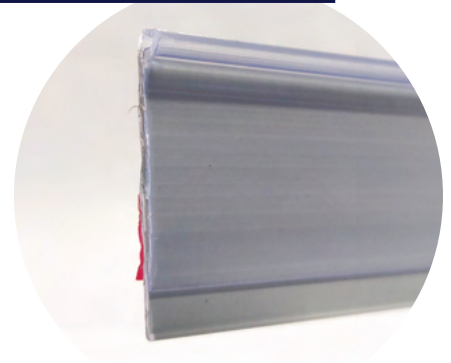

PE 04 - Com adesivo próprio para fixação.

## PEG BOARD PARA GANCHOS



PE 05 - 55mm A. x 75mm C.



# FARMÁCIA

GÔNDOLAS COMPACTAS  
PARA PRODUTOS MENORES.

**PGFP**



**DIMENSÕES**

2,10m = 6 bandejas;  
1,20m = 3 bandejas.

**Podium:**

0,84m C. x 0,40m L.  
x 0,20m A.

**Bandejas:**

0,99m C x 0,20m L.

PASSO  
**25** MM

CAPACIDADE  
**35** KG  
POR BANDEJA

PODIUM  
**100** KG

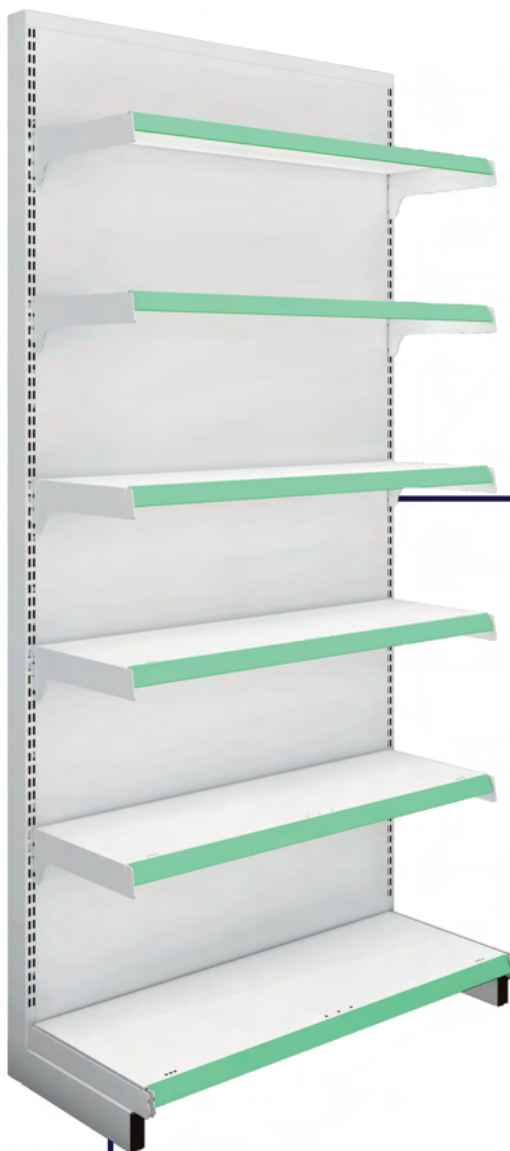

**MLFP**

**DIMENSÕES**

2,10m = 1 base + 5, 6 ou  
7 bandejas.

**Base:**

0,99m C. x 0,30m L.

**Bandejas:**

0,99m C. x 0,20m L.



**MCFP**

**DIMENSÕES**

2,10m = 2 bases +  
12 bandejas;

1,20m = 2 bases + 6  
bandejas.

**Base:**

0,99m C. x 0,30m L.

**Bandejas:**

0,99m C. x 0,20m L.

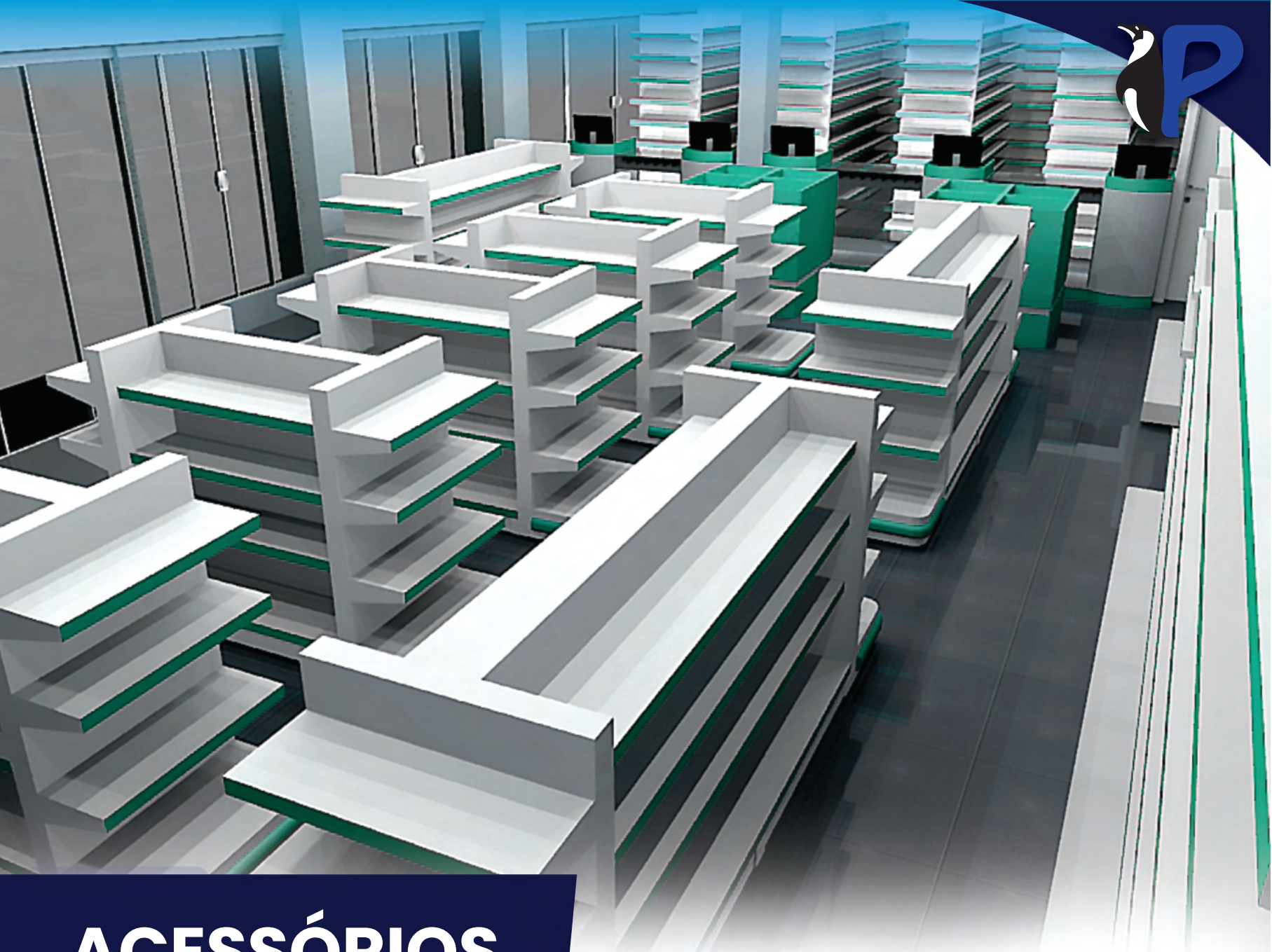

# ACESSÓRIOS

**CESTO PARA GÔNDOLAS**



## **DIMENSÕES**

0,98m C. x 0,36m L. x 0,20m A.  
atrás x 0,12m A. frente

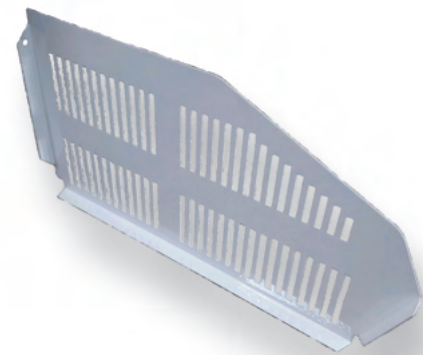

**GRADE DIVISÓRIA PARA CESTOS**

**BRANCO**

**PRETO**

**CORES**

# ACESSÓRIOS

BRANCO

CORES

PRETO

GCH

**GCH 07**



Gancho simples. Cód.: 4129  
Ferro 3/16" - Comp. 24cm

**GCH 10**



Gancho simples. Cód.: 7764  
Ferro 1/4" - Comp. 34cm

**GCH 02**



Gancho duplo para espetos  
e vassouras. Cód.: 3652  
Ferro 5/16" - Comp. 34cm

**GCH 08**

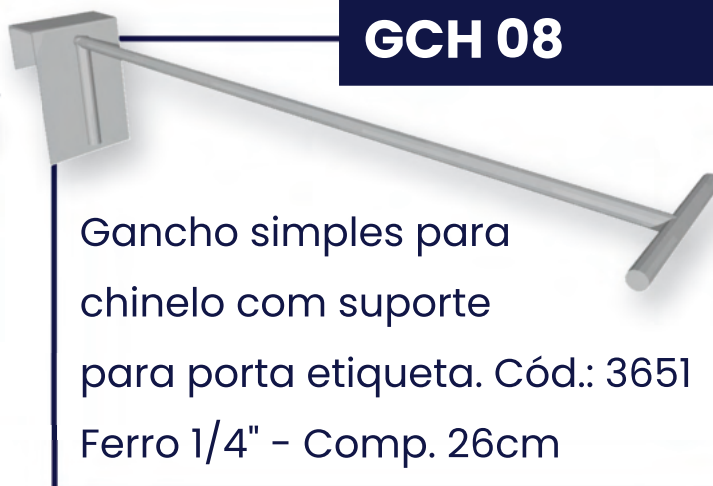

Gancho simples para  
chinelo com suporte  
para porta etiqueta. Cód.: 3651  
Ferro 1/4" - Comp. 26cm

**GCH 06**

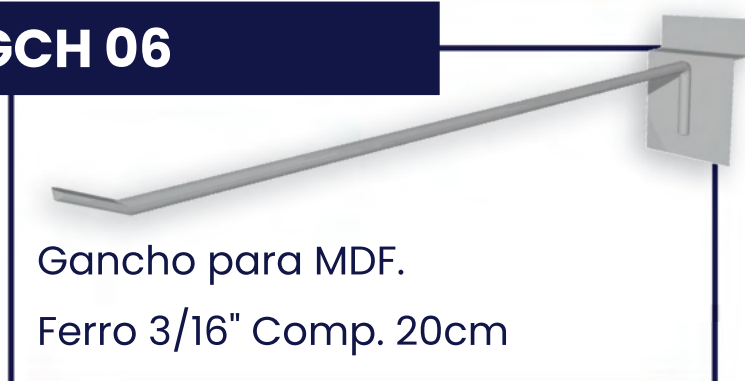

Gancho para MDF.  
Ferro 3/16" Comp. 20cm

**GCH 03**



Gancho para  
ferragem com suporte para  
porta etiqueta. Cód.: 7871  
Ferro 1/4" Comp. 36cm

**GCH 11**



Gancho simples para furos  
Cód. 6.130.0119  
Ferro 1/4" Comp. 21cm

**GCH 04**



Gancho para  
martelo com suporte para porta  
etiqueta. Cód.: 6.130.0057  
Ferro 5/16" Comp. 40cm

## GRADE FRONTAL

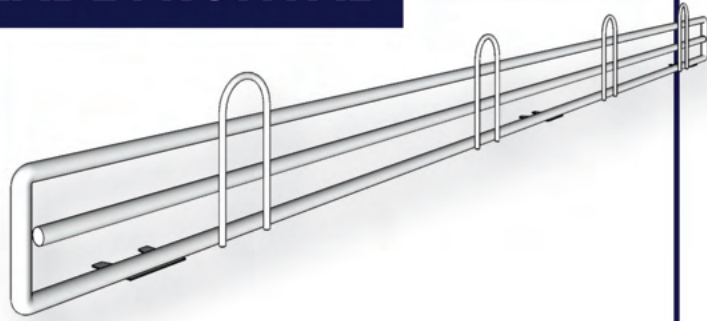

Gôndola: 97 x 5,5cm

Ponta de gôndola: 90 x 5,5cm

## BARRA PARA GANCHO



Para gôndola e  
ponta de gôndola

## SUPORTE P/ LÂMPADAS

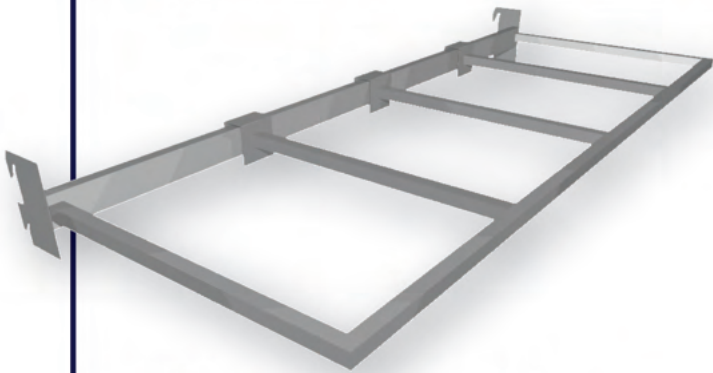

Suporte para luminárias,  
pendentes e outros

## SUPORTE PARA ROLOS

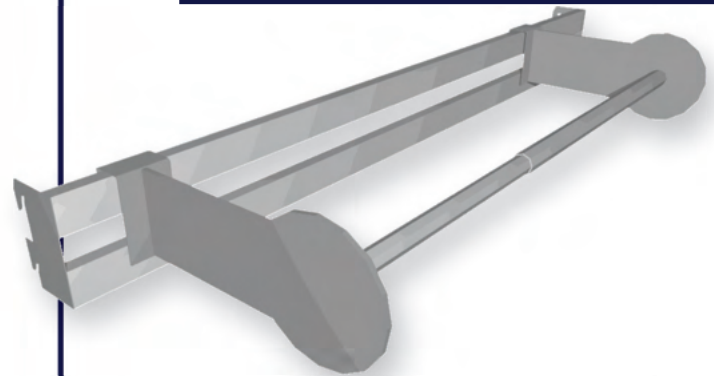

Suporte para rolos de  
tecidos, cordas e outros

## BANDÔ ILUMINADO

**MELHOR ILUMINAÇÃO = MAIOR DESTAQUE  
PARA OS SEUS PRODUTOS**



Modelo reto ou curvo

Iluminação em LED

Testeira em Inox ou em acrílico

## GANCHO PARA BANANAS

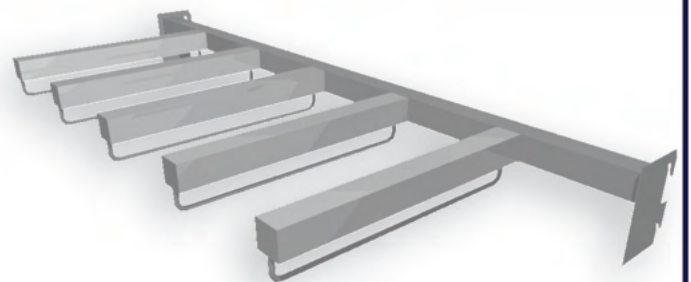

Gancho para bananas com  
tubo 30x20mm

Ferro 1/4" Comp. 37cm

BRANCO

CORES

PRETO

# CARACTERÍSTICAS GÔNDOLAS

## CORES DISPONÍVEIS

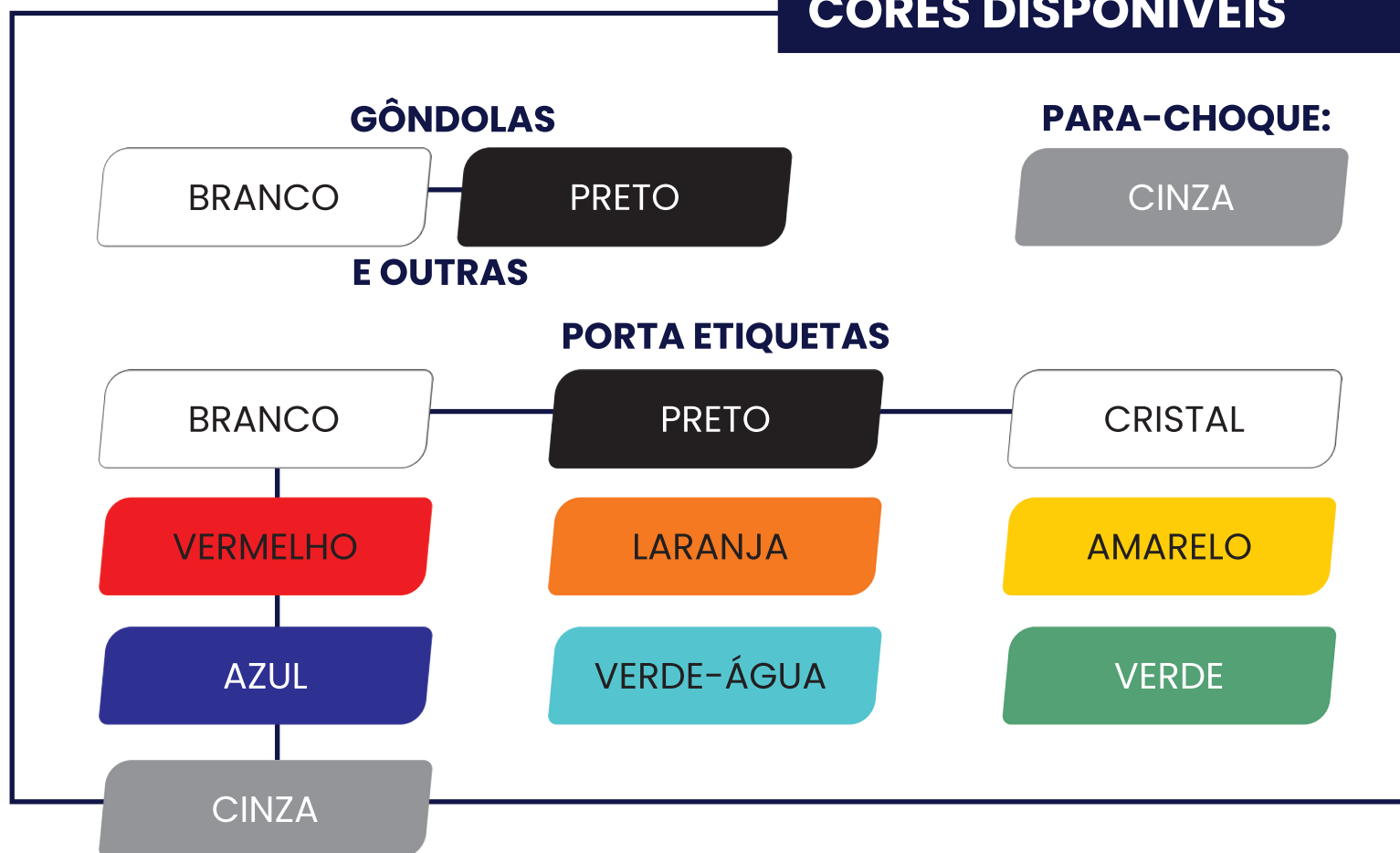

- Pintura Eletrostática a Pó;
- Porta Etiqueta com Visor de Cristal;
- Regulagem de alturas em todas as bandejas com passo de furação de 25mm;
- Sistema de encaixe sem parafusos;
- Reforço em W nas bandejas;
- Possibilidade de inclinação das bandejas.

## CARACTERÍSTICAS GERAIS

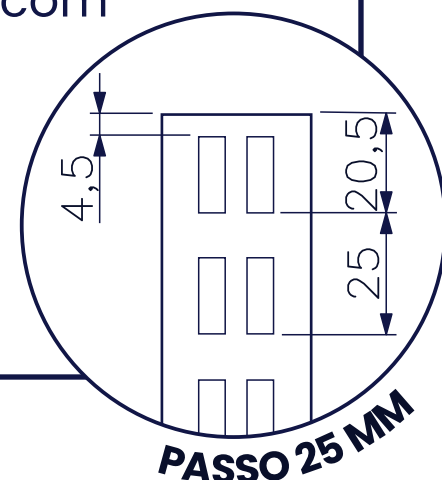

**Devido a constante pesquisa de desenvolvimento e melhorias de nossos produtos, as informações e imagens deste catálogo são ilustrativas e poderão sofrer alterações sem aviso prévio.**





## RÁPIDO

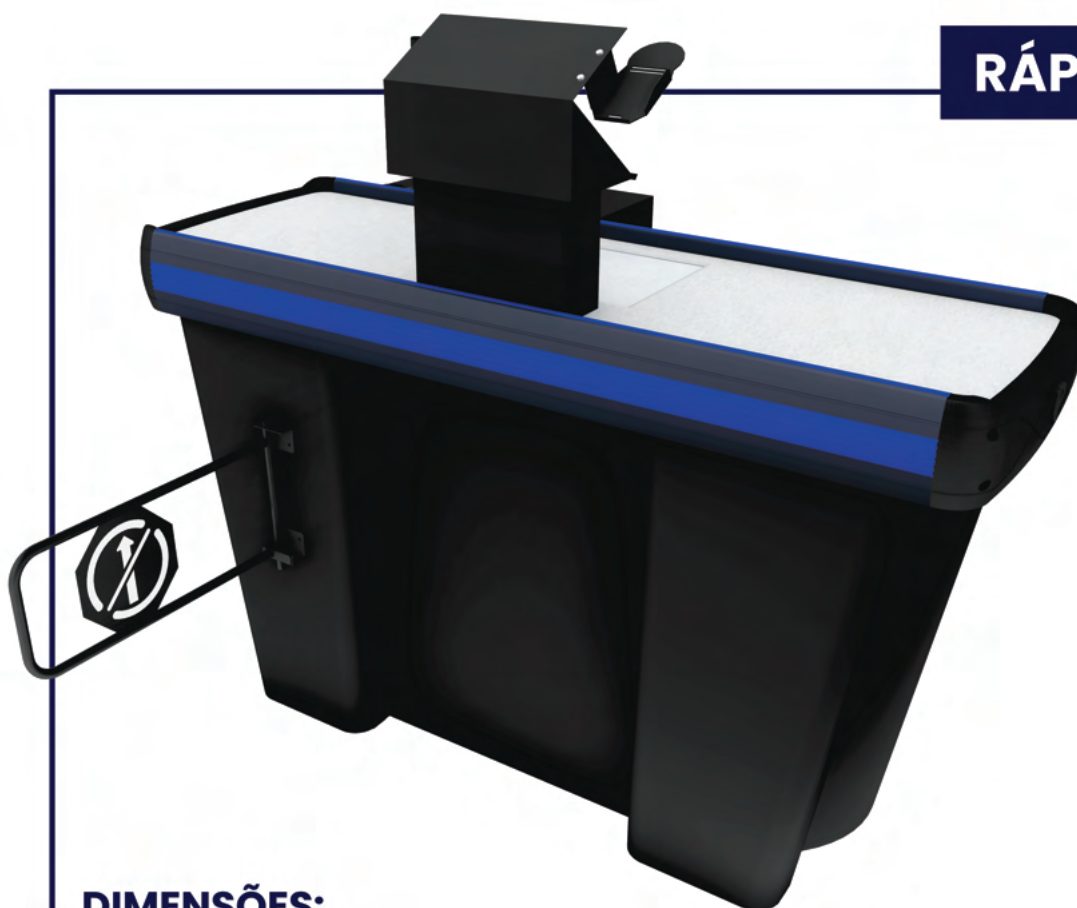

LADOS

VISTAS  
EXTERNA E INTERNA

### ESQUERDO E DIREITO

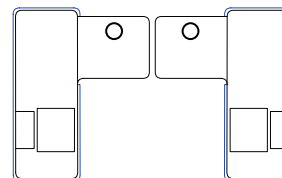

### DIMENSÕES:

**CHK 140:** 1,40m C. x 1,10m L. x 0,95m A.

## PADRÃO EM "L"

### ESQUERDO E DIREITO

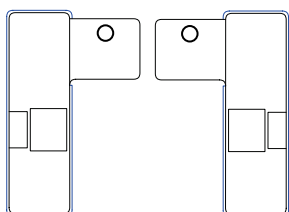

LADOS

VISTAS

EXTERNA E INTERNA



### DIMENSÕES:

**CHK 170:** 1,70m C. x 1,10m L. x 0,95m A.

# CHECK-OUT

DESENVOLVIDOS CONFORME  
A NORMA NR17 – ERGONOMIA

## PADRÃO EM "U"

ESQUERDO E DIREITO

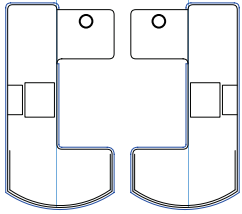

LADOS

VISTAS  
EXTERNA E INTERNA



**DIMENSÕES:**

**CHK 210:** 2,10m C. x 1,10m L. x 0,95m A.





COM PONTEIRAS ANTI IMPACTO EM PU INTEGRAL SKIN

COM ESTEIRA

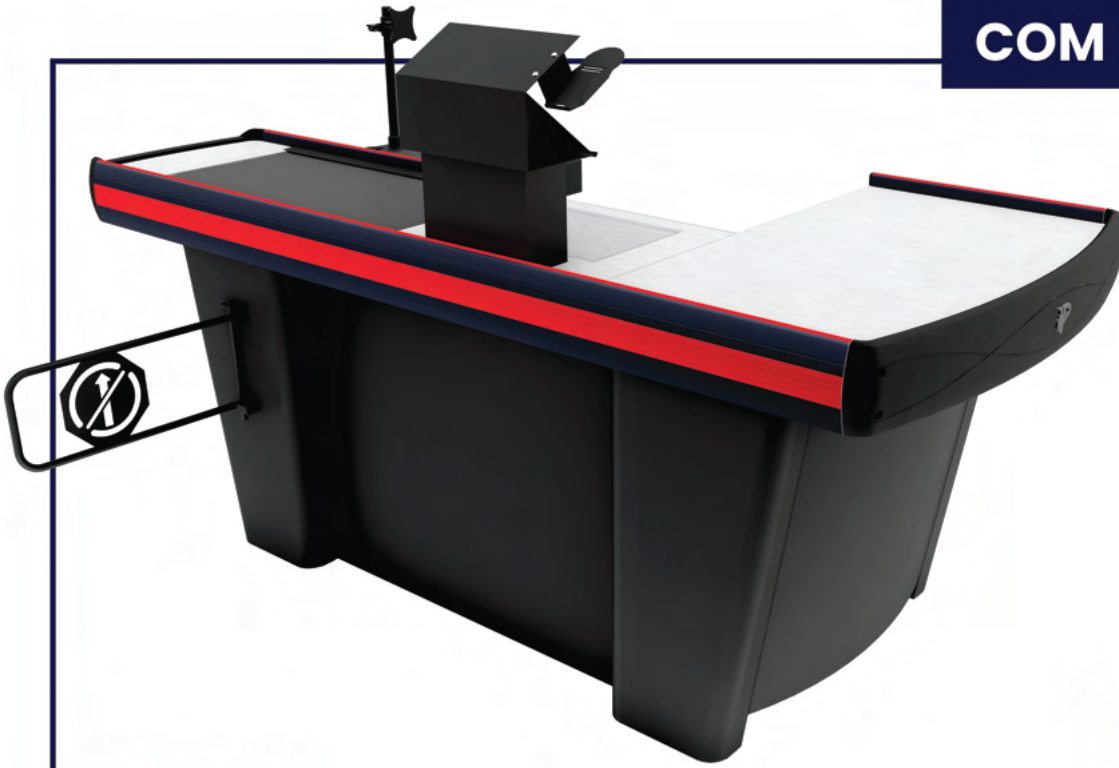

**DIMENSÕES:**

**CHK 240/E:** 2,40m C. x 1,10m L. x 0,95m A.

**CHK 270/E:** 2,70m C. x 1,10m L. x 0,95m A.

**CHK 300/E:** 3,00m C. x 1,10m L. x 0,95m A.

ESQUERDO E DIREITO

LADOS

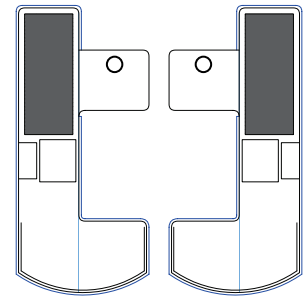

VISTAS  
EXTERNA E INTERNA



# CARACTERÍSTICAS CHECK-OUT

## CORES DISPONÍVEIS



- Pintura Eletrostática a Pó;
- Tampo em aço inox escovado;
- Opção de lado direito ou esquerdo;
- Gaveta com divisor de cédulas e moedas.

## CARACTERÍSTICAS GERAIS

### SUPOORTE PARA MONITOR



### ITENS INCLUSOS:



### CANCELA DE RESTRIÇÃO DE ACESSO

### SUPOORTE PARA LEITOR ÓPTICO E MÁQUINA DE CARTÃO (PIN PAD)



# CHECK-STANDER



## CKSP 01

### DIMENSÕES:

1,06m C. x 0,45m L. x 1,20m A.

### COMPOSTO POR:

**01** cesto superior 860mm x 440mm x 50mm;

**05** cestos laterais 805mm x 190mm x 100mm (atrás) / 55mm (frente);

**01** cesto frontal 420mm x 190mm x 100mm (atrás) / 55mm (frente);

**48** ganchos GCH II, 210mm.

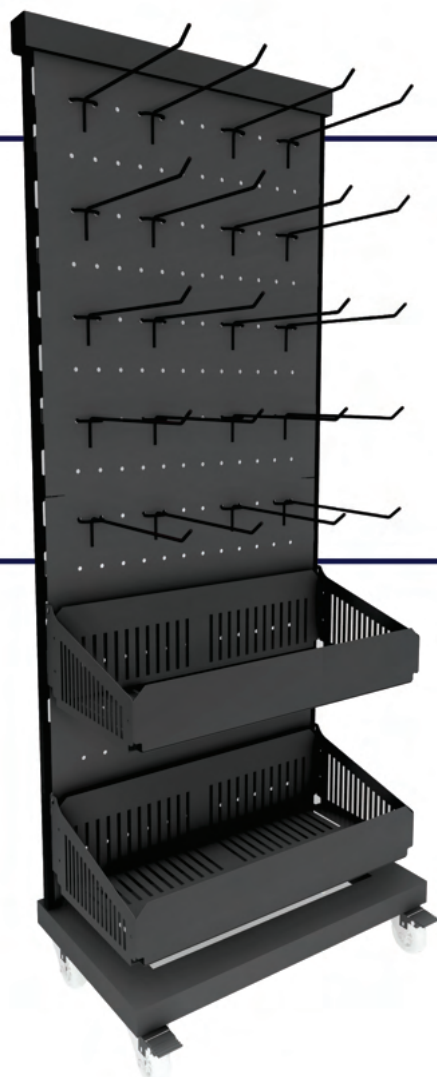
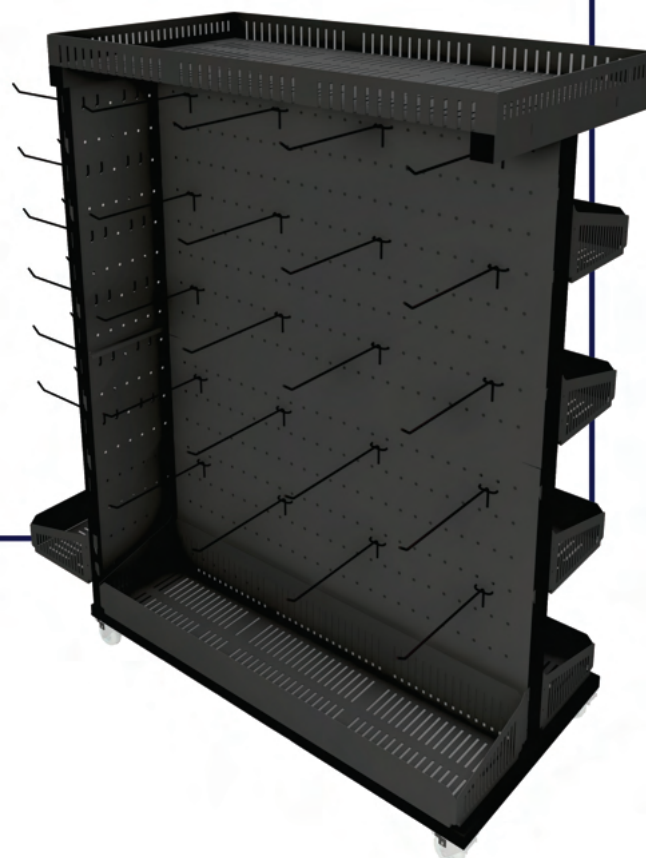
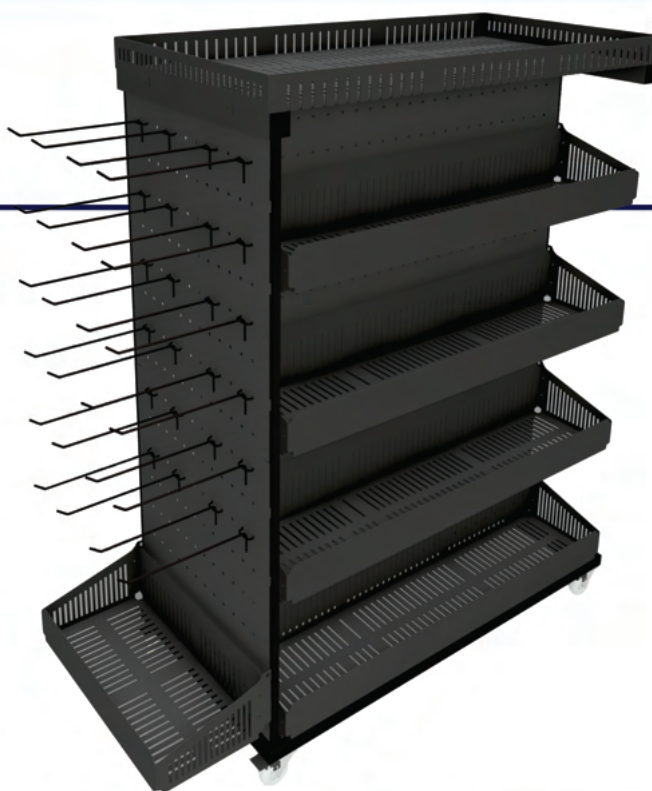

BRANCO

CORES

PRETO

## CKSP 02

### DIMENSÕES:

0,25m C. x 0,45m L. x 1,14m A.

### COMPOSTO POR:

**02** cestos frontais 420mm x 190mm x 100mm (atrás) / 55mm (frente);

**20** ganchos GCH II, 210mm.

ROD. SC283 | SAÍDA PARA CHAPECÓ  
RUA ITÁLIA | 1124 | BARRAÇÃO | BAIRRO DAS NAÇÕES  
89770-000 | SEARA | SC  
WWW.PERACCHI.IND.BR | ATENDIMENTO02@PERACCHI.IND.BR  
FONE: (49) 3452-1426 | (49) 3452-0151  
WHATSAPP: (49) 3452-1426  
INSTAGRAM: PERACCHI.EQUIPAMENTOS  
FACEBOOK: PERACCHI.LTDA



A TECNOLOGIA DO FUTURO É O NOSSO PRESENTE